

Healthcare sector





Open to the future

Keeping a firm commitment to excellence lead us to develop products that are 100% Manusa. We guarantee that they meet the highest quality standards, both in Spain and in our branches in Portugal, Brazil and China. As well as in the rest of the world, where we work with our exclusive suppliers, trained in our own facilities. Our aim: to be open to the world, always maintaining utmost attention and service demanded by our customers. Wherever that may be.

Open to leadership

The Manusa Group, created more than 50 years ago, has grown to become a leading company in the creation, design and development of all types of intelligent access. Thanks to our determined commitment to innovation and technology, we put our expertise to work in installations found in every corner of the globe. We accommodate the latest market trends and open doors to the future, getting ever closer to you.

Open to excellence

We maintain the highest level of excellence throughout each project, from the start to after-sales maintenance. We only use premium-quality materials when manufacturing our doors, subjecting them to the highest controls, to guarantee perfect operation and absolute peace of mind for our customers.

Open to you

More than 20,000 access points designed, manufactured, installed and maintained each year by our expert team of professionals in over 90 countries, guaranteeing convenience for millions of people. Because our guiding principal is the development of access points and services with drive and integrity, so we can adapt at any moment to changing times and the real needs of people. In order to continue being a trusted partner.

Aimed at connecting

At Manusa we are working every day on achieving the full satisfaction of our customers. Our commitment is to innovate, maintaining a vocation of service to others and providing them with everything required.

We develop hospital solutions and have the best partners to respond to all of them, from identifying user needs to integrating the most suitable systems, including installation and after-sales.

Contents

Introduction	3
Contents	5
360° solution	7
Basic concepts	9
Hermetic doors	11
Hermetic sliding door	13
Hermetic swing door	17
Lead-lined sliding door for X-ray rooms	21
Hermetic glazed door	25
Finishes and accessories	29
Hermetic Visio+	31
Vector	33
Customisation	35
Frames and finishes in HPL	37
Hermetic door accessories	39
Other solutions for the healthcare sector	41
Automatic sliding doors	42
Semi-hermetic doors	42
Telescopic break out doors	43
Balanced doors	43
Fixed windows	44
Panic break-out doors	44
Fire rated glazed doors	45
High-speed doors	45
Access control systems	46
Custom-made solutions	48
FAQs	50

360° solutions

Manusa offers a **comprehensive service with effective solutions** for all areas of a hospital complex.

This all contributes to maintaining the **hygiene, safety** and **comfort** of both workers and patients and can be totally adapted to specific requirements. There is also the option to equip Manusa devices with access control systems or manage them remotely thanks to the **IoT technology** built into our operators.

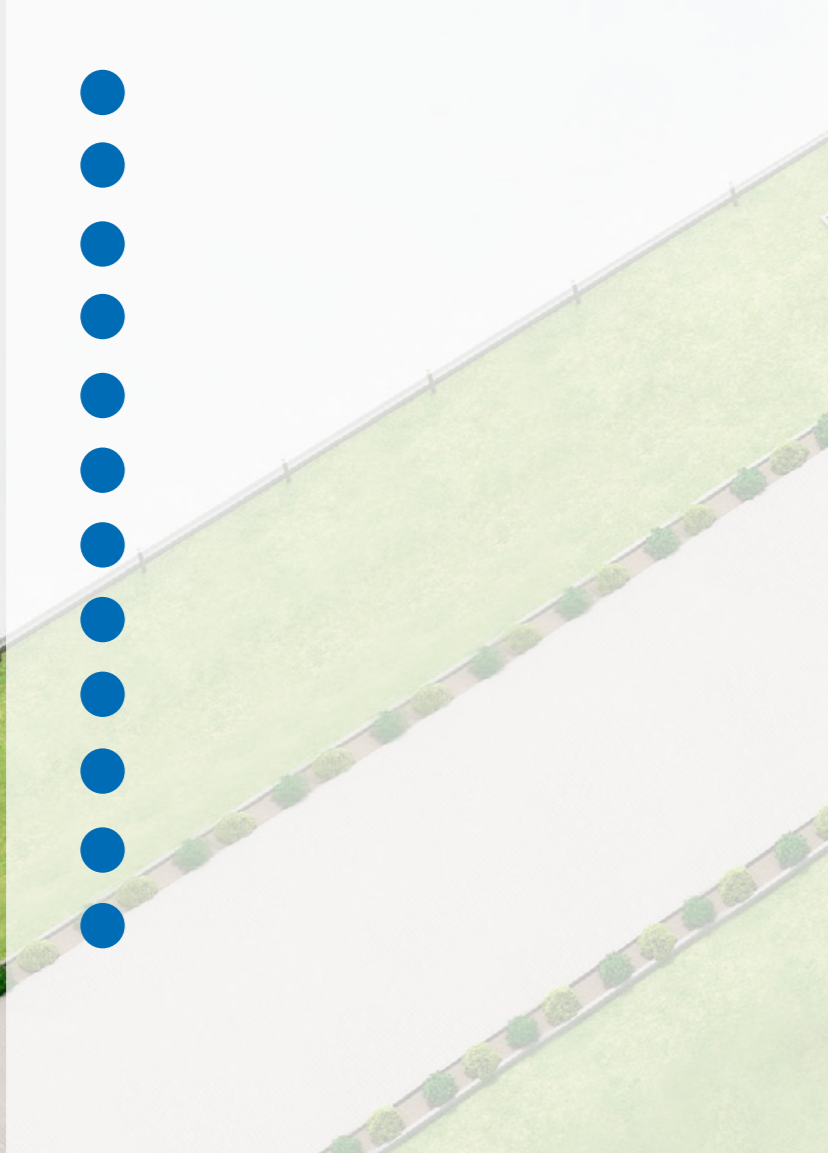

Airtightness and clean rooms

Basic principles

Don't attract

- It is very important to avoid dust escaping from the HEPA filters and frames as well as to keep the pressure regulated in the room. To ensure an optimum level of hygiene and cleanliness, anyone entering the room must do so after changing their clothing and receiving an air shower. Similarly, any material or equipment brought into the room must also be sterilized.

Don't accumulate

- Ensuring that technical equipment does not have any corners or edges that are difficult to clean is fundamental to controlling the condition of white rooms. Making sure that pipes and tubing are not exposed and creating a cleaning routine is important in order to achieve the necessary environmental conditions.

Don't generate

- Using dust-free clothing and not using materials that generate it easily is another factor that has to be taken into consideration as a basic principle for achieving the conditions of a clean room. It also helps not to move unnecessarily and not to bring in disused items.

Remove quickly

- To increase the air change rate, it is important to avoid placing air generating equipment close to areas prone to dust and to create a suitable air pattern that prevents it from sticking.

Basic concepts

POSITIVE PRESSURE

Purpose: To keep the clean room in aseptic conditions.

How: By preventing the entry of untreated or contaminated air into the room by keeping a difference of pressure between two rooms.

Process for achieving positive pressure environment:

- Through forced air purifiers, fresh air is collected, purified and moved into the clean room.
- During this process the bacteria is burnt and eliminated.
- The recovery of air inside the room is less than the air that enters.
- This process can only be achieved by sealing all the openings.
- The hermetic door ensures the effectiveness of this process by keeping a positive pressure.

NEGATIVE PRESSURE

Purpose: To keep rooms adjoined to a contaminated area in aseptic conditions.

How: By evacuating contaminated air.

Process for achieving negative pressure environment:

- By forcing contaminated air out of the room through air purification machines.
- Air absorption is higher than the air introduced in the room.
- This process can only be achieved by sealing all the openings.
- The hermetic door ensures the effectiveness of this process.

CLEAN CORRIDOR AND DIRTY CORRIDOR

Clean corridor: For access of patients, doctors and other persons with access to operating theatre or clean rooms.

Dirty corridor: used by maintenance staff to access a clean room, collect the tools and clothes used during the operation, and take them to decontamination area.

- The surgery room must be equipped with two doors: one leading a clean corridor and a back door leading to a dirty corridor.
- The hermetic door prevents clean corridor and clean rooms being contaminated by separating them from a dirty area.
- Both doors must function in an airlock configuration.

Hermetic doors

Hygiene

Due to their flush-surfaced design and the use of easy-clean materials, Manusa's hermetic doors can maximise hygiene levels in hospital environments.

Safety

Reduction in installation workload, increasing their life expectancy and substantially decreasing the number of faults, leading to lower maintenance costs.

Functionality

The advanced, exclusive mechanism designed by Manusa equips our doors with excellent low air permeability as well as being user-friendly and practical.

Aesthetics

Minimalistic lines and perfect finishes on any surface. Our doors offer a design adapted to each space and requirement.





Hermetic sliding door

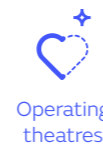

Operating theatres



Clean rooms



Laboratories

With bi-part or single-slide options, Manusa's sliding doors combine the advantages of an automatic door with the airtightness and hygiene required in clean environments.

The hermetic sliding door consists of one or two sliding leaves which move sideways automatically, opening up a wide clearance area for public transit whilst hermetically sealing the perimeter of the aperture once closed. It also allows the leaf to open in the event of a power failure, using a handle to open the door.

In order to guarantee correct hermetic sealing, the leaf drops down 15 mm towards the floor and fits 10 mm into the frame of the opening so as to seal the perimeter of the door opening.

Technical specifications

Hermetic sliding doors form part of the solutions that Manusa offers for laboratories, hospitals and environments related to the healthcare sector and all types of white rooms in industrial environments, where the air has special conditions.

MOTOR GROUP ELECTRICAL SPECIFICATIONS

Standard power supply	220-240V ± 6% 50-60 Hz
Power source option	100-120V ± 6% 50-60 Hz
Motor	2 x Three-phase AC
Nominal Power	250 W
Inverter Technology (exclusive to Manusa)	VV-VF
Protection fuse	3.15 A (220V) / 5A (110 V)
Operating temperature	-15°C to 50°C
Transport and storage temperature	-15°C to 50°C
Rechargeable antipanic battery	1 x 12 V DC 700 mAh

KINEMATIC SPECIFICATIONS OF THE MOTOR GROUP





Adjustable leaf opening speed	≤ 1 m/s
Adjustable leaf closing speed	0.15 to 0.6 m/s
Maximum acceleration	0.8 m/s ²
Maximum weight of LD leaves (single/bi-parting)	1x90 Kg / 2x65 Kg
Maximum weight of HD leaves (single/bi-parting)	1x200 Kg / 2x150 Kg

OPERATOR CHASSIS TECHNICAL SPECIFICATIONS

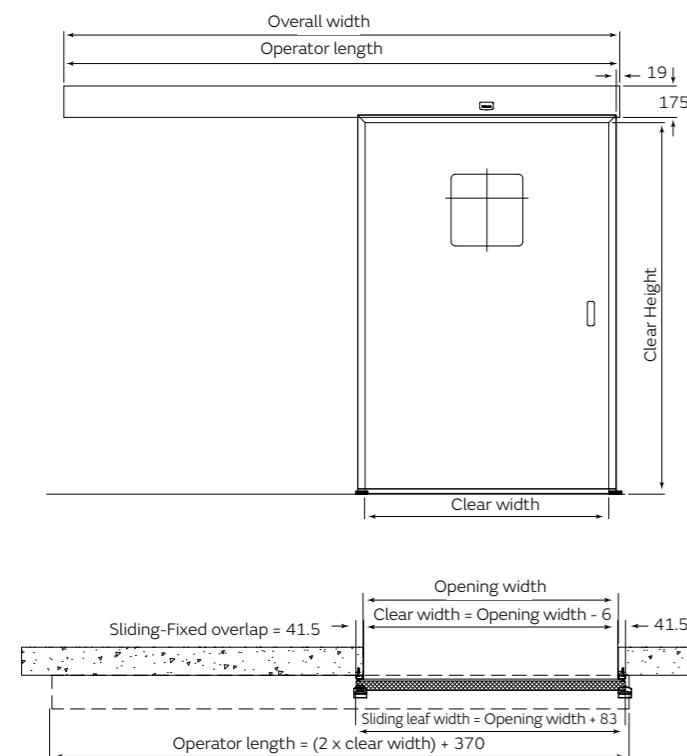
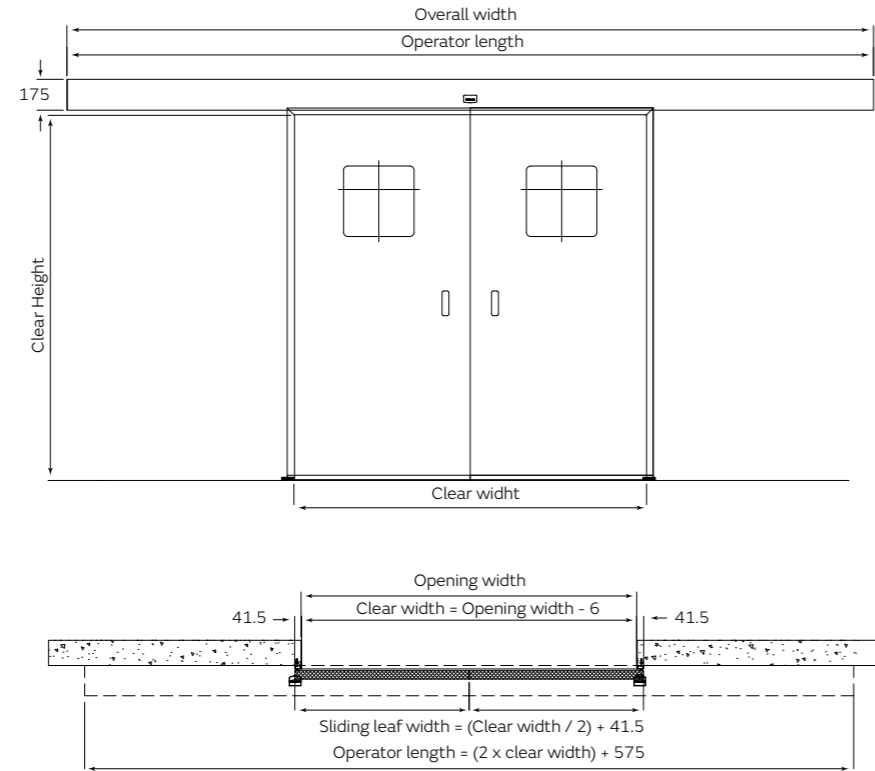
Operator dimensions (height x depth)	175 x 220 mm
Maximum operator length	5900 mm
Single slide clearance (min./max.)	495 / 1800 mm
Bi-part clearance (min./max.)	1070 / 2660 mm
Recommended maximum clear height	2400 mm

Drawings



-  The entire door guarantees low air permeability
-  Bi-part or single slide opening
-  Smooth design with flush surfaces
-  Stainless steel finish, HPL or mixed

Technical information and finishes

Hermetic sliding door

Hermetic sliding door leaves are available in HPL, in AISI-304 and AISI-316 stainless steel (the latter being especially recommended for corrosive and saline environments), mixed (HPL and stainless steel) and glass*.

The low air permeability features of our doors are due to the airtight seal fitted around the entire perimeter for the leaf. The hermetic Visio + operator and the MK40 frame make it possible to guarantee the correct functioning of a hermetic sliding door on any type of wall. When the leaf/leaves close/s they approach the frame, sealing the perimeter of the door opening.

Manusa's hermetic sliding doors have been tested with the aim of determining the product's air permeability at low pressures. The tests have been performed with positive and negative overpressure on the sliding door.



There is the option to place a double-glazed vision panel, flush with the leaf, in an easy-to-clean, elegant design, available in different shapes and sizes. The vision panel can have a Venetian blind built into it or self-dimming glass. There is also the option to make the vision panel with its maximum size, leaving an outer frame of 150 mm in HPL or stainless steel finish.

* For other finishes, please consult the Technical Department.





Hermetic swing door

- 
 Operating theatres
- 
 Clean rooms
- 
 Laboratories

Single or double hermetic swing doors can be manual or automatic by integrating a swinging operator.

This product is especially recommended for the healthcare sector in which cleanliness is paramount, thanks to the frame's smooth surface, as well as no visible screws. It is also extremely safe, with elements that ensure electrical continuity for correct electrostatic discharge.

When the leaf closes, it seals itself at the side and top against the frame. At the bottom, there is a mechanical system that lowers to perform a function in relation to the floor. Its design makes it possible to maintain the positive or negative pressure in the clean room as required.

Technical specifications

The hermetic swing doors are manufactured under strict quality control conditions to guarantee functioning according to the highest levels of compliance with hygiene measures.

MOTOR GROUP ELECTRICAL SPECIFICATIONS

Standard power supply	230V ± 10% AC 50/60Hz
Nominal power	85 W
Max. shaft output	45Nm
External devices power supply	15 VDC - 12 W Max.
Operating temperature	-10°C to 50°C
Service	Continuous

KINEMATIC SPECIFICATIONS OF THE MOTOR GROUP

Opening time	3s (70°/s) ÷ 6s (20°/s)
Closing time	4s (40°/s) ÷ 15s (20°/s)
Closing force (according to 1154)	EN4 ÷ EN6
Maximum opening angle	110°
Door leaf width	700 ÷ 1400mm
Protection rating	IP40

OPERATOR CHASSIS TECHNICAL SPECIFICATIONS

Operator dimensions (height x width x length)	89 x 130 x 675 mm
Minimum single slide door dimensions	605 x 1934 mm (PL x HL)
Maximum single slide door dimensions	1154 x 2457 mm (PL x HL)
Maximum LEADED single slide door dimensions	929 x 2457 mm (PL x HL)
Minimum bi-parting door dimensions	1260 x 1934 mm (PL x HL)
Maximum bi-parting door dimensions	2358 x 2457 mm (PL x HL)
Maximum LEADED bi-parting door dimensions	1916 x 2457 mm (PL x HL)

Drawings

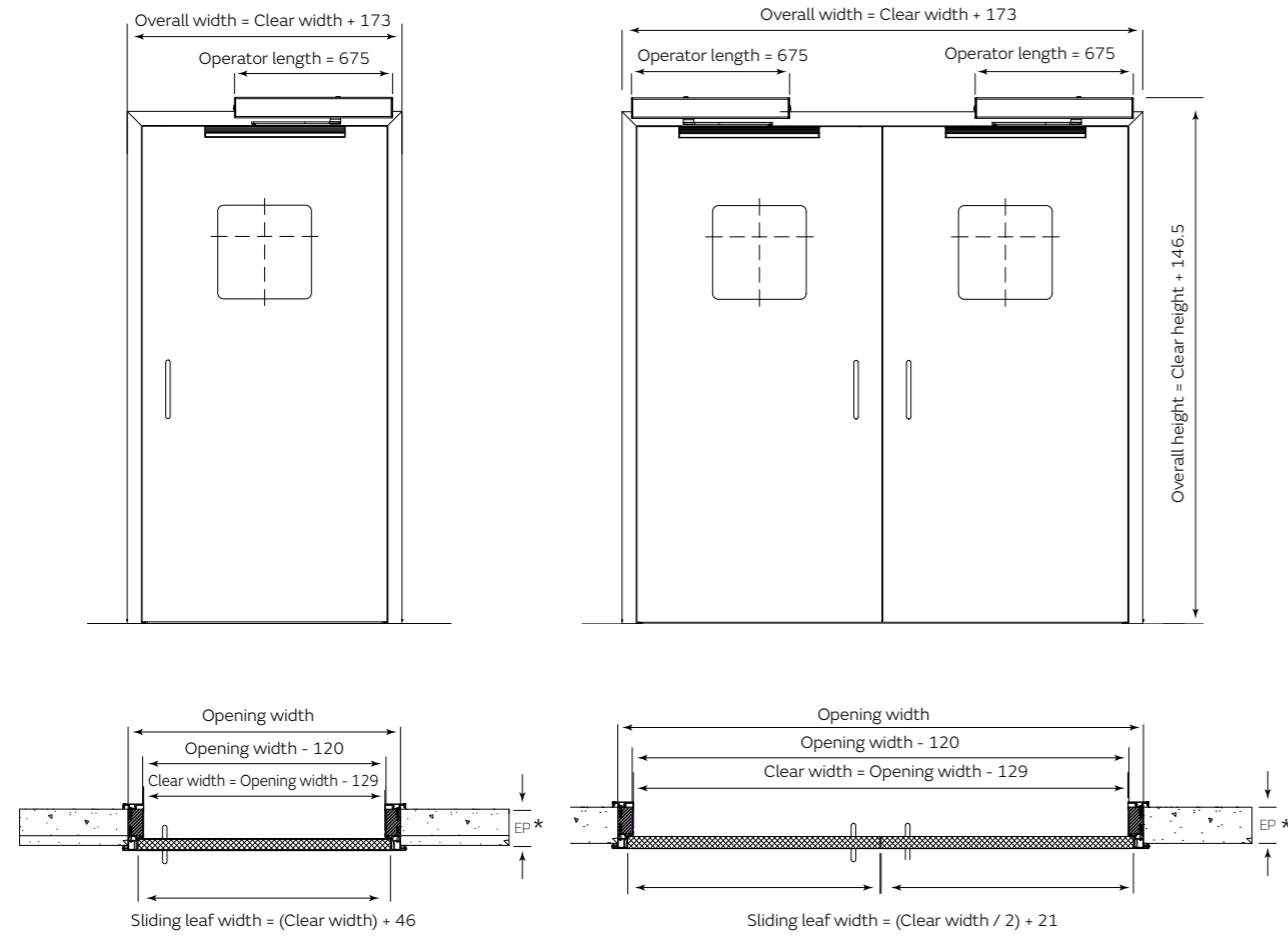

Bi-part or single slide opening



Manual or automatic opening



The entire door guarantees low air permeability



Stainless steel finish, HPL or mixed

Technical information and finishes

Hermetic swing door



Hermetic swing door leaves are available in HPL, in AISI-304 and AISI-316 stainless steel (the latter being especially recommended for corrosive and saline environments), mixed (HPL and stainless steel) and glass*.

Whenever hermetic swing doors need to be installed between two rooms at different pressures, the doorset should be designed and installed so that the positive pressure always acts in the same direction as the leaf closes, thus helping to keep the door closed.

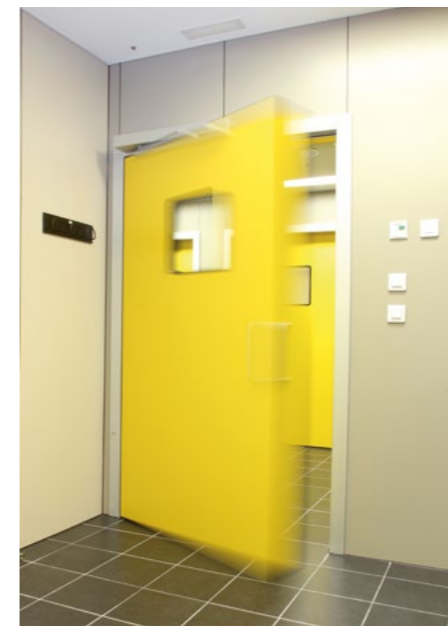

The MKB frame is specially designed to guarantee the correct functioning of a hermetic swing door on any type of wall. It makes it possible to cover the opening where you want to place the door on both sides, offering a smooth, solid block which ensures that the leaf is correctly coupled. Its design makes it possible to adapt to any wall with thicknesses greater than 60 mm. There is also the option to make the vision panel with its maximum size, leaving an outer frame of 150 mm in HPL or stainless steel finish.

The hinges are completely hidden and integrated between the frame and the leaf. When the door is closed, the hinges are not visible at all.

* On-site structural framing. Needed to install the Manusa frame.

* For other finishes, please consult the Technical Department.



Lead-lined sliding door for X-ray rooms



The automatic lead-lined doors for X-ray rooms guarantee adequate insulation in such areas thanks to the lead lining on the leaf and the anti-radiation treatment applied to the viewing panels.

The door offers comprehensive protection against radiation since the leaf contains continuous sheets of lead inside it, which in turn overlap with the lead in the walls of the x-ray rooms. Vision panel with lead-lined glass and camera to allow viewing whilst protecting against X-rays.

Designed for protection against X-ray room radiation, it has a hygienic and sanitary design which is highly resistant to impacts, chemicals and humidity. For intensive use being highly robust and safe in radiological conditions.

Technical specifications

There are bi-part, single-slide, hermetic and non-hermetic options as well as one- or two-leaf swing doors.

MOTOR GROUP ELECTRICAL SPECIFICATIONS

Standard power supply	220-240V ± 6% 50-60 Hz
Power source option	100-120V ± 6% 50-60 Hz
Motor	2 x Three-phase AC
Nominal Power	250 W
Inverter Technology (exclusive to Manusa)	VV-VF
Protection fuse	3.15 A (220V) / 5A (110 V)
Operating temperature	-15°C to 50°C
Transport and storage temperature	-15°C to 50°C
Rechargeable antipanic battery	1 x 12 V DC 700 mAh

KINEMATIC SPECIFICATIONS OF THE MOTOR GROUP *

Adjustable leaf opening speed	≤ 1 m/s
Adjustable leaf closing speed	0.15 to 0.6 m/s
Maximum acceleration	0.8 m/s ²
Maximum weight of LD leaves (single/bi-parting)	1x90 Kg / 2x65 Kg
Maximum weight of HD leaves (single/bi-parting)	1x200 Kg / 2x150 Kg





OPERATOR CHASSIS TECHNICAL SPECIFICATIONS *

Operator dimensions (height x depth)	175 x 220 mm
Maximum operator length	5900 mm
Single slide clearance (min./max.)	495 / 1800 mm
Bi-part clearance (min./max.)	1070 / 2660 mm
Recommended maximum clear height	2400 mm

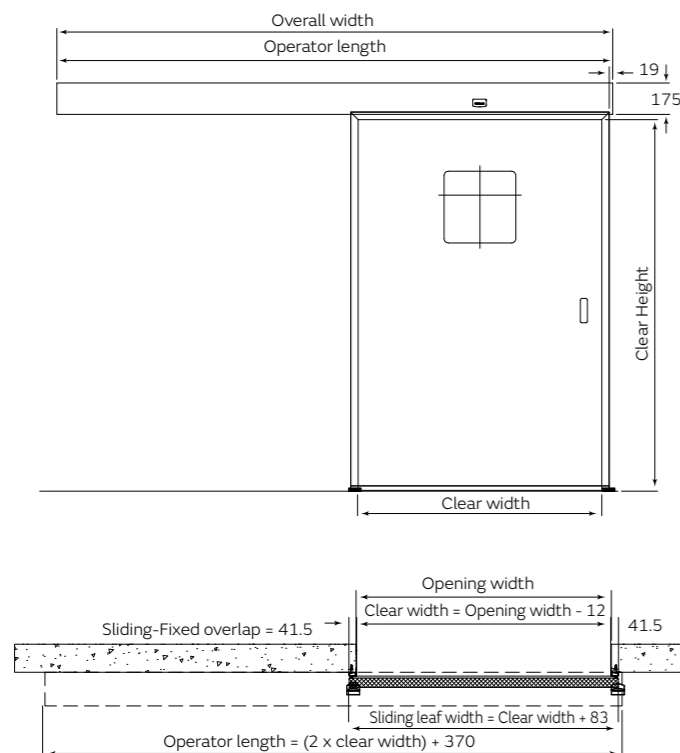
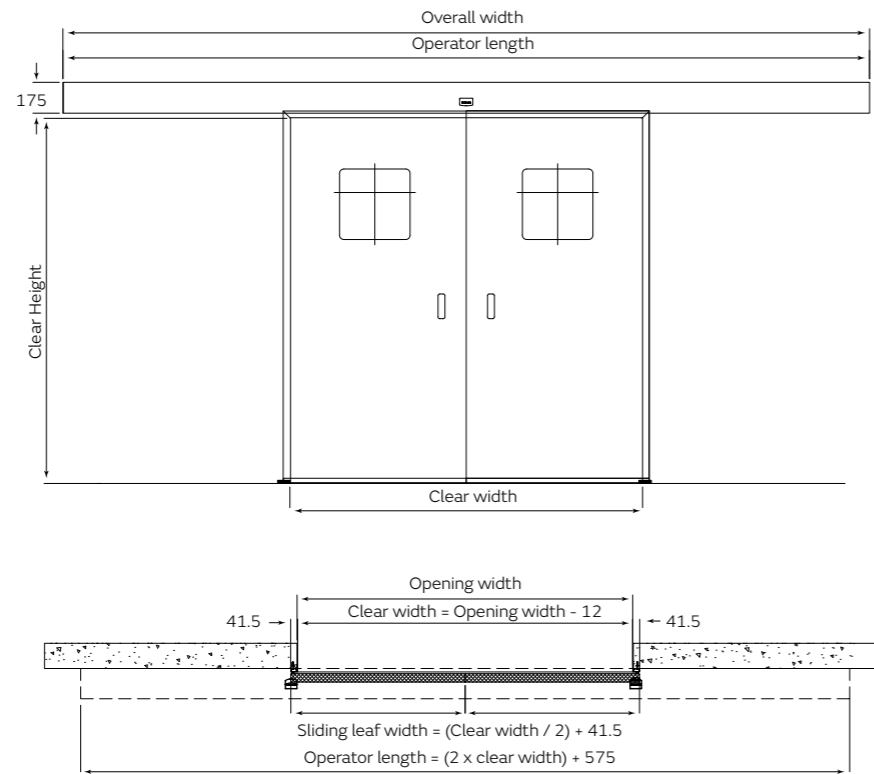
* The kinematic and technical specifications correspond to the hermetic operator. For a non-hermetic operator, please consult the Technical Department.

Drawings



-  Isolation thanks to the lead lining on the leaf
-  Sliding or swing opening
-  Smooth design with flush surfaces
-  Hermetic or non-hermetic door depending on the requirements.

Technical information and finishes

Lead-lined door for X-ray rooms

The leaves of lead-lined sliding doors are available in HPL and AISI-304 and AISI-316 stainless steel. The standard thickness of the lead is 2 and 3 mm.*

The low air permeability features of our doors are due to the airtight seal fitted around the entire perimeter for the leaf. The hermetic Visio + operator and the MK40 frame make it possible to guarantee the correct functioning of a hermetic sliding door on any type of wall. When the leaf/leaves close/s they approach the frame, sealing the perimeter of the door opening.

For correct operation, it is important to know the variables of the rooms, such as the workload, the distance from the radiology equipment to the door, the use of the area on the other side of the door, the characteristics of the X-ray equipment, etc.

Double glazing vision panel and lead-lined glass to allow viewing whilst protecting against X-rays.

There are also doors for **MRI rooms**, with copper mesh inside them.

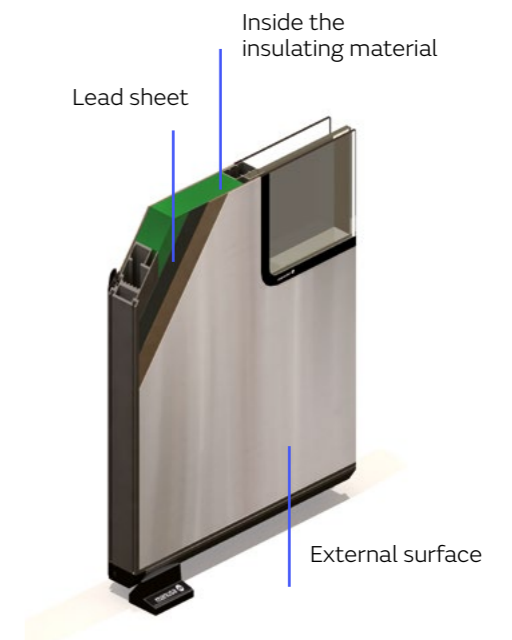

* For other thicknesses, please consult the Technical Department.



Hermetic glazed door



ICU

These doors are suitable for observation rooms since they provide great visibility inside the room, whilst also guaranteeing a hermetic seal.

Product designed specifically to guarantee low air permeability because when the leaf/leaves close, they approach the frame and the floor, hermetically sealing the perimeter of the aperture.

Hence, we maintain a positive or negative pressure, inside the white room with the added feature of the leaves being completely glazed.

A common application for this type of door leaf is in ICU and CCU rooms, so that patients can be monitored and supervised from the outside.

The frame is designed to cover the clear width of the opening on the side of the leaf and can be adapted to any wall, ensuring a flat contact surface with the leaf to guarantee airtightness.

Technical specifications

They enable hospital staff to medically monitor each of the modules that compose ICUs, CCU rooms resuscitation, pre-anaesthesia, etc.

MOTOR GROUP ELECTRICAL SPECIFICATIONS

Standard power supply	220-240V ± 6% 50-60 Hz
Power source option	100-120V ± 6% 50-60 Hz
Motor	2 x Three-phase AC
Nominal Power	250 W
Inverter Technology (exclusive to Manusa)	VV-VF
Protection fuse	3.15 A (220V) / 5A (110 V)
Operating temperature	-15°C to 50°C
Transport and storage temperature	-15°C to 50°C
Rechargeable antipanic battery	1 x 12 V DC 700 mAh

KINEMATIC SPECIFICATIONS OF THE MOTOR GROUP

Adjustable leaf opening speed	≤ 1 m/s
Adjustable leaf closing speed	0.15 to 0.6 m/s
Maximum acceleration	0.8 m/s ²
Maximum weight of LD leaves (single/bi-parting)	1x90 Kg / 2x65 Kg
Maximum weight of HD leaves (single/bi-parting)	1x200 Kg / 2x150 Kg

OPERATOR CHASSIS TECHNICAL SPECIFICATIONS

Operator dimensions (height x depth)	175 x 220 mm
Maximum operator length	5900 mm
Single slide clearance (min./max.)	495 / 1800 mm
Bi-part clearance (min./max.)	1070 / 2660 mm
Recommended maximum clear height	2400 mm

Drawings

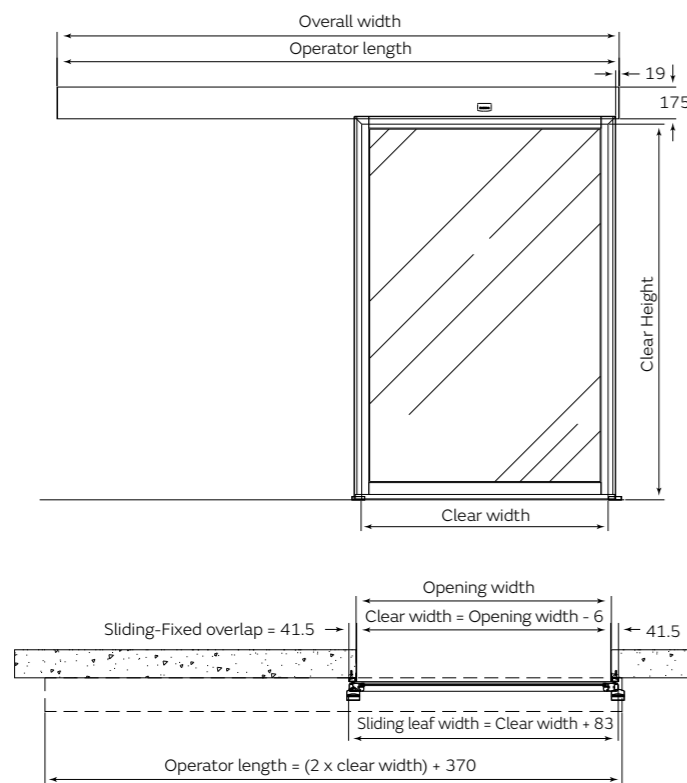
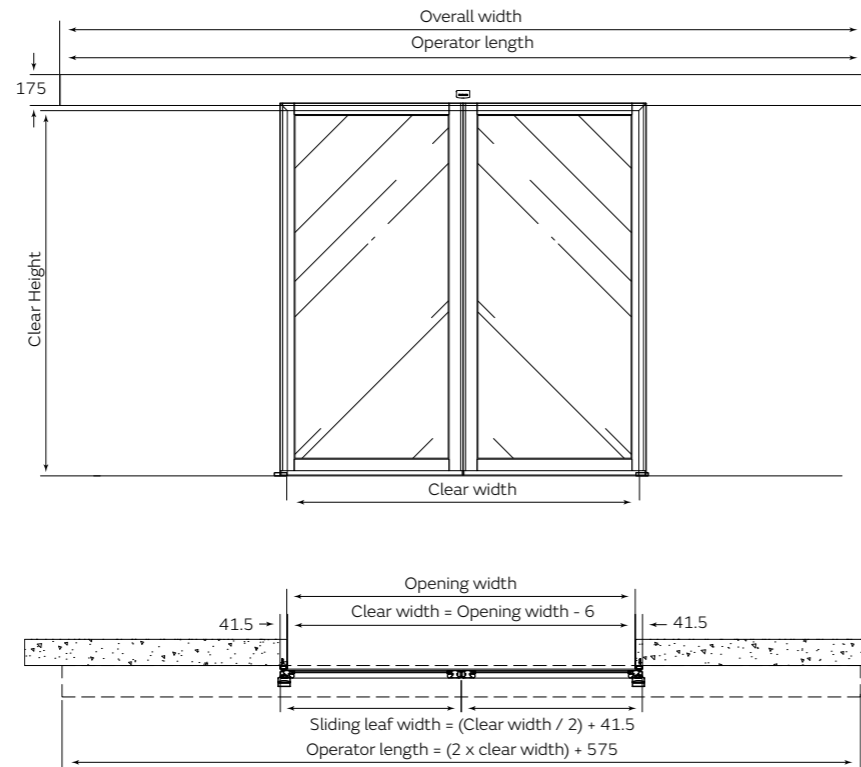

The entire door guarantees low air permeability



Ideal visibility for the observation room



Extruded aluminium finish.



Self-dimming glass or glass with integrated Venetian blind (optional)

Technical information and finishes

Hermetic glazed door

This door is made in aluminium, which permits an anodised or lacquered finish. The latter is available in the entire RAL range.

The leaves made with extruded aluminium with a thickness of 44 mm, frame the whole perimeter of the glass by means of a glazing gasket. It is compatible with all types of conventional safety glass: laminated, tempered, with standard thicknesses between 6 and 10 mm.

If greater visibility is desired for the hermetic glazed door, a fixed leaf can be added, when it is single slide door, or two fixed leaves for a bi-parting door. Hence, patient visibility is maximised and virological contamination is minimised.

Optionally, when a certain level of privacy is required, there is the option to install self-dimming glass or glass with an integrated Venetian blind, which provides the door with opacity or transparency at any given time.



Customisation, finishes and accessories

Manusa offers a wide range of accessories suitable for healthcare environments, which enable safe, hygienic access and prevent any type of contact.

Our accessories are designed to boost the functional nature of each of our doors.



Hermetic Visio+

Manusa's hermetic Visio+ operator permits the administration and management of smart accesses safely and remotely. It enables you to immediate contact the maintenance service besides being able to manage every spaces separately, assigning customised access, in accordance with the requirements requested.



Automatic lock
Two models available:
standard or fail-safe



Profiles
Numerous combinations.

Easy access
Front cover with flexible hinge for easier access.



Three-phase AC motors
Direct Drive technology

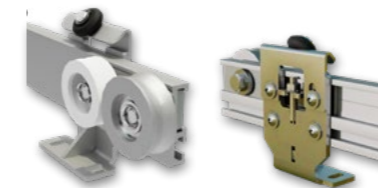

Track solution
Track rail and trolleys to guarantee silent operations.



High-performance control electronics
VV-VF Inverter technology and Advanced Motor Control Management for uniquely smooth movements.
Auxiliary battery.

Filter
Ensures compliance with regulations and reduces costs in the event of faults due to power surges.

Manusa Bus*
Greater possibilities and easy connection of accessories.

Product certified by the following laboratories:



Associated certificates:



Certificate of **durability for 1 million cycles** according to Standard UNE 16361:2014+A1:2017

* MANUSA BUS: connection system between the control electronics and the accessories that provides maximum reliability and easy installation. Automatically recognises accessories without having to switch off the operator (Plug & Play).

Vector

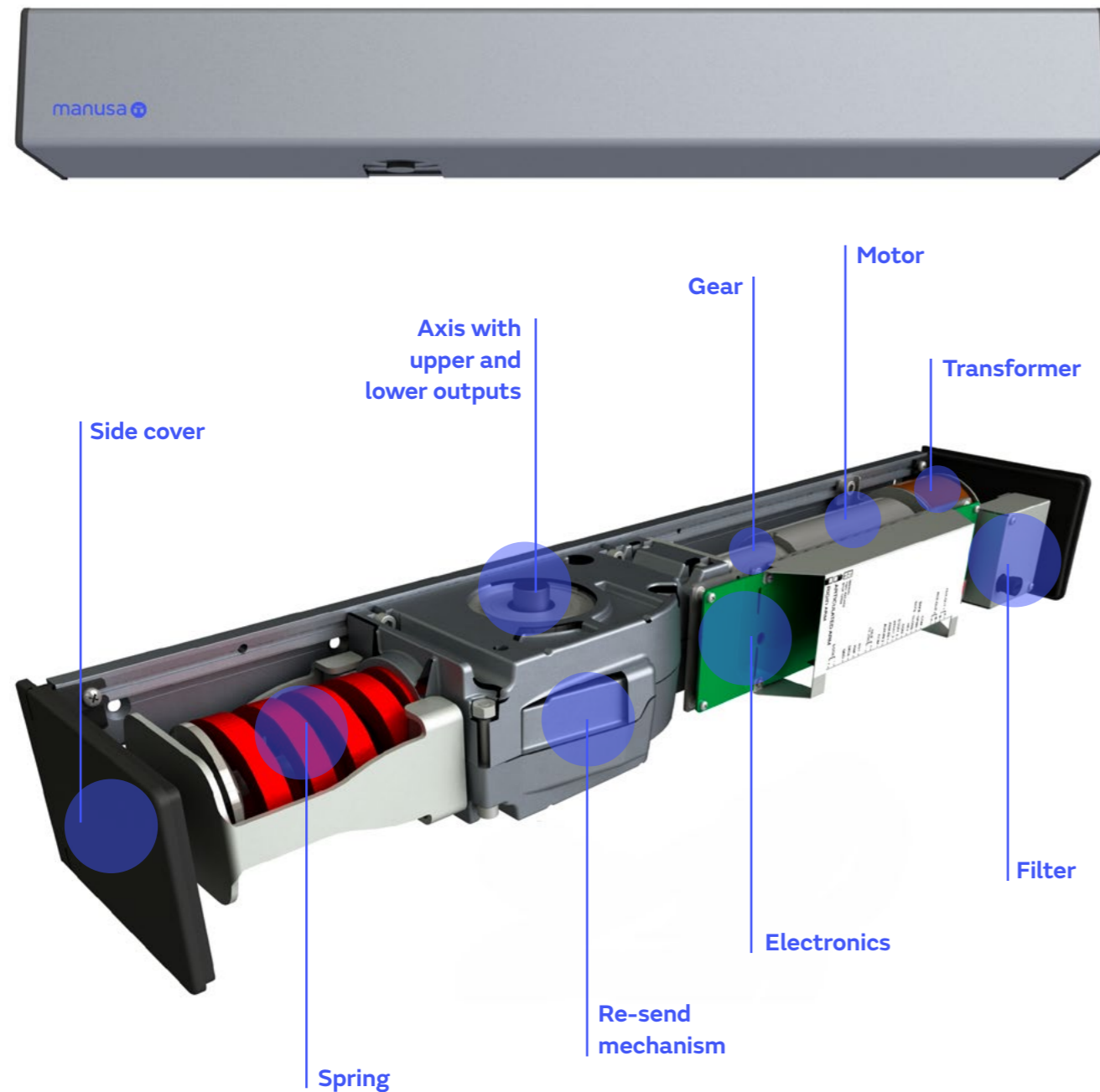

Vector is an advanced electromechanical operator used for the automation of any type of new or existing swing door.

It is a highly-efficient, high-performance operator, especially designed for intensive use, as it can automate both light and very heavy doors.

It is available with pull or push arms for single-slide and bi-parting door versions.

- **Compact** design, with minimum aesthetic impact.
- Attractive and formal design with pleasant lines.
- Door closing by means of a **motor-assisted spring** in normal operation.
- Door closing by means of **spring** in case of power supply failure.
- Available modes for **Low Energy** and **Push&Go** activation.
- **Easy installation** and monitoring thanks to its built-in double display
- Built-in mode selector: manual, automatic and stop open mode.
- Possibility to interlock the doors.
- Optional 5 modes selector on surface (available under request).

Pull arm

Attached to the wall on the same side as the hinges.



SLIM pull arm



Push arm

Attached to the wall on the opposite side as the hinges.

- Short push arm $0 \leq x \leq 150$
- Long push arm $150 \leq x \leq 300$



Associated certificates:



Customisation

Door closer **

Built-in door closer EN 2-4.

HPL finish ***

- It consists of phenolic resin as standard, antibacterial certification according to standard JIS Z 2801.
- Standard colours: blue, green, white and beige.

Handle **

- Only handle
- Handle + Key
- Handle + Lock
- Only key

Handle

- Tubular handle 600mm*
- Tubular handle 250mm*
- Embedded finger grip

* Antibacterial tubular handle

Manusa offers the option of Bioproof® treatment consisting of applying colourless powder paint, which provides superior resistance to various micro-organisms that are harmful to health. With this treatment, between 99.5 and 100% of these micro-organisms are eliminated.

** Only available for manual doors. Not compatible with automatic doors.

*** Available with Bs2d0 classification: this means that it reacts well to fire (close to non-flammability), moderate smoke emission and does not release droplets or persistent flaming particles.

Vision panels

Vision panels make it possible glance inside the room. They can be customised as follows:

- **Shapes and sizes:** circular, oval, square, rectangular etc.
- **Glass with integrated Venetian blind:** double glazing including a Venetian blind which provides total isolation from the outside and prevents dirt and deterioration resulting from humidity or contact.
- **Self-dimming glass:** switches from opaque to transparent through an electric current. It is most useful when separating environments, providing immediate privacy.

- Standard
- ▨ Automatic Venetian blind
- Pb Leaded
- Self-dimming glass



• For other available finishes, please consult the Technical Department

Frames for hermetic doors

The frames for Manusa's hermetic doors are designed to ensure that the doors operate correctly on any type of wall.

Hermetic sliding doors

The MK40 frame for hermetic sliding doors is designed to cover the door openings on one or both sides of the wall.

It is specifically designed to guarantee the door's airtightness, cleanliness and security. Its innovative clip assembly system allows the frame to rest on the entire surface of the finish chosen by the client and can be adapted to any wall thickness. It can also be used as a purely decorative element.

Hermetic swing doors

The MKB frame for hermetic swing doors is also designed to ensure the door performs optimally. It makes it possible to cover the opening where you want to place the door on both sides, offering a smooth, solid block, also called a block frame, which ensures that the leaf is correctly coupled and supported.

Finishes in HPL

Due to the technical nature of printing, there may be differences between the printed colour and the real colour of the material.

STANDARD COLOURS

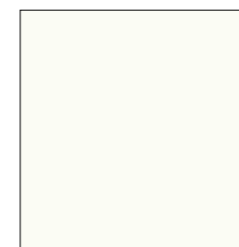

White

Ref. 0085FH

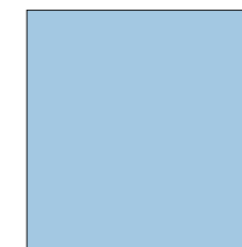

Arctic

Ref. 0718FH

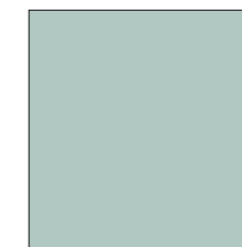

Sea green

Ref. 0630FH

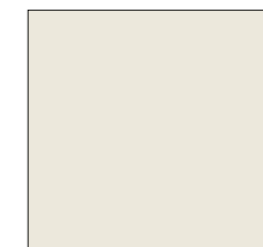

Pebble grey

Ref. 0742FH

NON-STANDARD COLOURS



Hygienic white

Ref. 0733FH

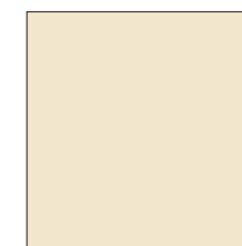

Light beige

Ref. 0624FH

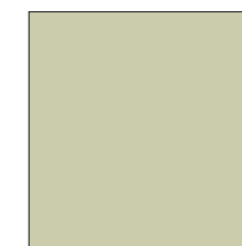

Papilio

Ref. 0061FH

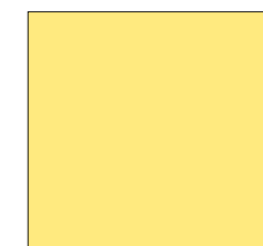

Camomilla

Ref. 2124FH

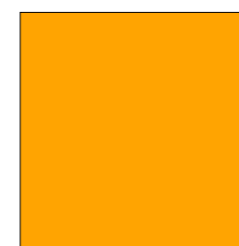

Diabolo

Ref. 0012FH



Atlantic

Ref. 0717FH

Hermetic door accessories

DRIVE: Drive systems to control safe opening.



DDS-S sensor
Side safety sensor.



DDS-A and DDS-B hybrid sensor
Hybrid presence and motion sensor.



Planar radar
Motion sensor.



Planar radar 2.0
Directional motion sensor.



Optima Prox+
Contactless drive. White or black finish.



Wireless card reader
For coded cards.



Photocell
Prevents accidental closures.



Push button and elbow push button
Device for opening the door. Available in wireless, surface and recessed version. White or silver finish.

CONTROL: to control the operating mode of doors and manage malfunctions.



Optima+ selector
Automatic door control program selector. White or black finish.



Optima Pocket+
Wireless automatic door control program selector.



Smart program selector
Selects operating mode on LCD screen.



Remote control
For remote management, can be combined with other controls.



Optima selector
Basic selector for the control of the automatic door



DoorWifi selector app
Mobile app for remote door management.

CONTROL: Systems to optimise efficient entry and exit management.



Manulink interface
Control software. Allows remote control and time programming.



Openlinx system
Door interconnector and controller. Remote management of automatic door operations from web browser and integration with industrial and building automation communication buses

SAFETY: Devices to control the entrance and exit, providing maximum user protection.



Numeric keypad
Also available in wireless version



Outside key switch
Also available in wireless version



Lock
To open or close the door using other accessories, such as the outside key switch, the remote control or the control program switch.
Floor lock ***
ERP lock ***
Leaf lock ***

OTHER CONTROL ACCESSORIES

Manusa e-Sat device, Technical service configurator.

OTHER AVAILABLE ACCESSORIES

Ledglass leaf lighting *** Customised designs using LED lighting.

Glass with integrated Venetian blind *** A blind integrated into the glass.

Self-dimming glass *** Allows the transparency of the leaves to be changed for specific privacy needs.

People counter *** Crowd measuring system for knowledge of entrance and exit traffic.

* Refer to the technical data sheets.

** The characteristics described in this document are purely informative and are in no way binding.

*** Consult our commercial department.

The manufacturer reserves the right to make modifications without prior notice.



Other solutions

Solutions that adapt to the safety requirements of any environment.

Manusa focuses on the comprehensive management of solutions for the access and safety of people and places.

We guarantee the safety of any environment by installing solutions that are compliant with the most demanding regulations. Our products adapt to the needs of the different sectors and to the requirements of each project through sophisticated safety systems for the peace of mind of both customers and users.

Automatic sliding doors

Automatic sliding doors are the most practical and functional on the market since they can be installed in main entrances, corridors, rooms, waiting rooms etc.

Versions available include bi-part, single slide, telescopic, curved and semi-circular. They can have transparent leaves or be entirely framed.

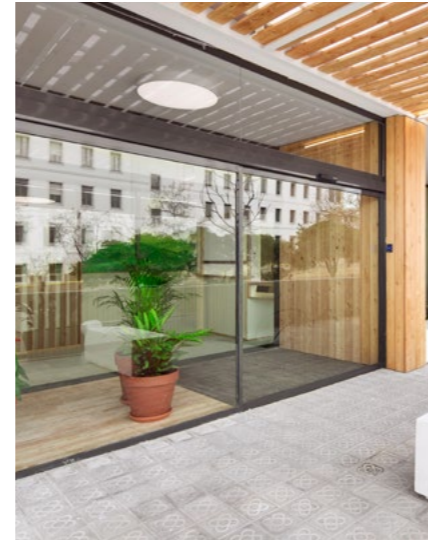

Partitioning



Entrance



Pharmacies

Telescopic break out doors

This type of door makes it possible to combine the telescopic opening with swing leaves. The leaves fold back on one another to provide maximum transit space on one of the sides of the door. Also, the leaves can be folded back simply by pushing them outwards to lie flat against a side, to allow extra transit space.

This is ideal for corridors or narrow areas where a complete opening is needed to facilitate the transit of stretchers, UCI equipment etc.



Partitioning

Semi-hermetic doors



Semi-hermetic sliding door for the healthcare sector, designed for rooms working with low differential pressure. This door is suitable for healthcare environments such as hospitals, white rooms or laboratories.

This type of door includes an aluminium frame and additional brushes on the leaf to reduce its air permeability.

It is made in aluminium and has finishes in glass, phenolic resin (HPL) or a combination of both.



Partitioning



Clean rooms



Laboratories



Pharmacies

Balanced doors



This type of door is especially recommended in cases where there is minimal installation space and maximum clearance is needed, such as a hospital corridor.

It opens particularly quickly and smoothly and its speed and force can be controlled separately.



Partitioning



Fixed windows

Fixed windows have been designed for visually monitoring the room from outside. They are mainly fitted in operating theatres, ICUs, X-ray rooms, etc.

Optionally, they include leaded protection or a system for regulating privacy using glass with an integrated venetian blind or self-dimming glass. If required, they can also be made with fire-resistant profiles.



ICU



Radiology



Operating theatres

Panic break-out doors

This product is particularly suitable for doors located on evacuation routes. In normal mode, a door with this type of leaf operates normally, but in the event of an emergency, a simple push is enough to fold the leaves back to the sides to provide a wider clearance.

There are different types of leaves with 40, 44 or 45mm thicknesses to cover the aesthetic and functional options required.



Partitioning



Car park



Emergency exit



Fire rated glazed doors

Fire rated glazed doors help to separate areas that pose a higher fire risk, preventing the propagation of fire outside of those areas, without the need to create unnecessary obstacles and always maintaining the aesthetics of the location.

The door remains closed and prevents the passage of flames, smoke, gases and significant heat transfer to the unexposed surface for a certain period of time (30 or 60 minutes, depending on the model).



Partitioning



Car park

High-speed doors

Our extensive product range adapts perfectly to the needs of any healthcare project.

High-speed doors can be used to divide indoor or outdoor areas with differently sized openings, close off areas with a high circulation of people and machinery, and even compartmentalise areas requiring specific conditions of air tightness.

- High-speed roll-up door for white rooms
- Sectional doors
- Rolling shutters



Laboratories



Clean rooms



Ambulance entrance

Access control systems

Access control systems make it possible to log who enters and exits in areas requiring this function, such as offices, operating theatres, pharmacies, etc. They also permit the integration of different control systems such as RFID cards, digital fingerprint readers, facial or voice recognition systems, etc.

We also offer a comprehensive solution that includes pass-through prevention, software and readers or, if you want to keep your current healthcare management system, it is possible to only change the pass-through prevention whilst keeping and integrating your software and your current readers.

At Manusa, we have a wide range of solutions, which can be adapted to the needs of any healthcare complex.

Speed gate with two-way swing panels

- The speed gate with two-way swing panels are combined to form passageways, they guarantee a quiet operation as well as a very safe option thanks to the fact that the access is supervised by photocell barriers to detect intruders.

Speed gate with one-way swing panels

- Speed gate with one-way swing panels are the safest solution for controlling access to areas with limited or restricted access or where strict control measures are required. It combines biometric identity verification and the checks from the surveillance lists and risk assessment databases to offer real, complete feedback.



Turnstiles

- They are available in different models: one that consists of a free-standing single-post turnstile and another formed by a compact double-post turnstile. Manusa turnstiles offer a reliable, convenient and inexpensive solution with the best technology.



Access control systems for bathrooms

This is an innovative opening system for controlling the entry to and exit from bathrooms using a validation or push button system. There are four possible opening systems adaptable to each client's needs:

- Single-door control
- Two-door control
- One-door control with a single inside button
- One-door control with a single outside button

This access system is designed to adapt to bathrooms that are accessed by a single door, shared bathrooms with two access doors, or an airlock system door. This solution is applicable for any type of automatic door, be it swing or sliding.

It is composed of an online operator and Manusa's own smart system consisting of a control box and an interface with buttons for opening, closing and locking. The buttons can also light up to show the status of the door and the bathroom (occupied and vacant).

This system may be installed in places where it is necessary to have an advanced and electromechanical control of bathroom access, such as hospitals, nursing homes, day-care centres, etc. and where there might be users with reduced mobility.

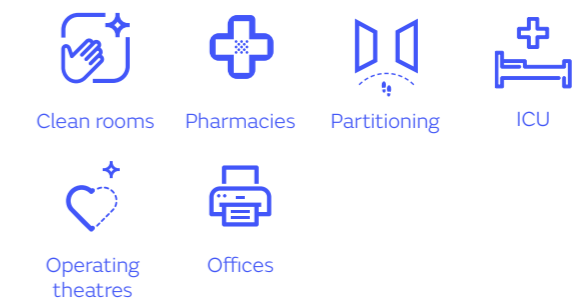

Custom-made solutions

We have a large R&D+i team with enough experience and know-how to carry out any project they are given. We offer 360° solutions that include all aspects of a hospital, since we are equipped with the latest technology to facilitate the optimisation of every process and the creation of smart solutions.

Remote management

Using IoT technology makes it possible to control connectivity and remotely control any Manusa access.

- Any action that you need to take in relation to your access can be managed from your mobile phone.
- Allocation of keys and access permissions.
- Creation of spaces for managing and grouping different accesses together.
- Different profile types, which make it possible to match functional features to individual needs.

Airlock system

Some hospitals have rooms that need to be controlled to prevent the transmission of pathogens, such as ICUs, acute burns units, laboratories, etc. In these cases, safety and strictly controlling access are of critical importance, and the airlock system makes this possible.

Regardless of the type of doors and access control chosen, the airlock offers many different external control and connectivity options so that it can be integrated into other control systems in the hospital and be managed and supervised.



Airlock system with sliding door

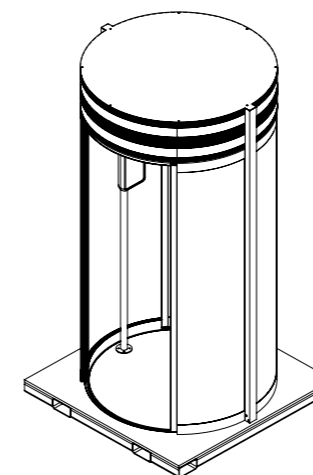
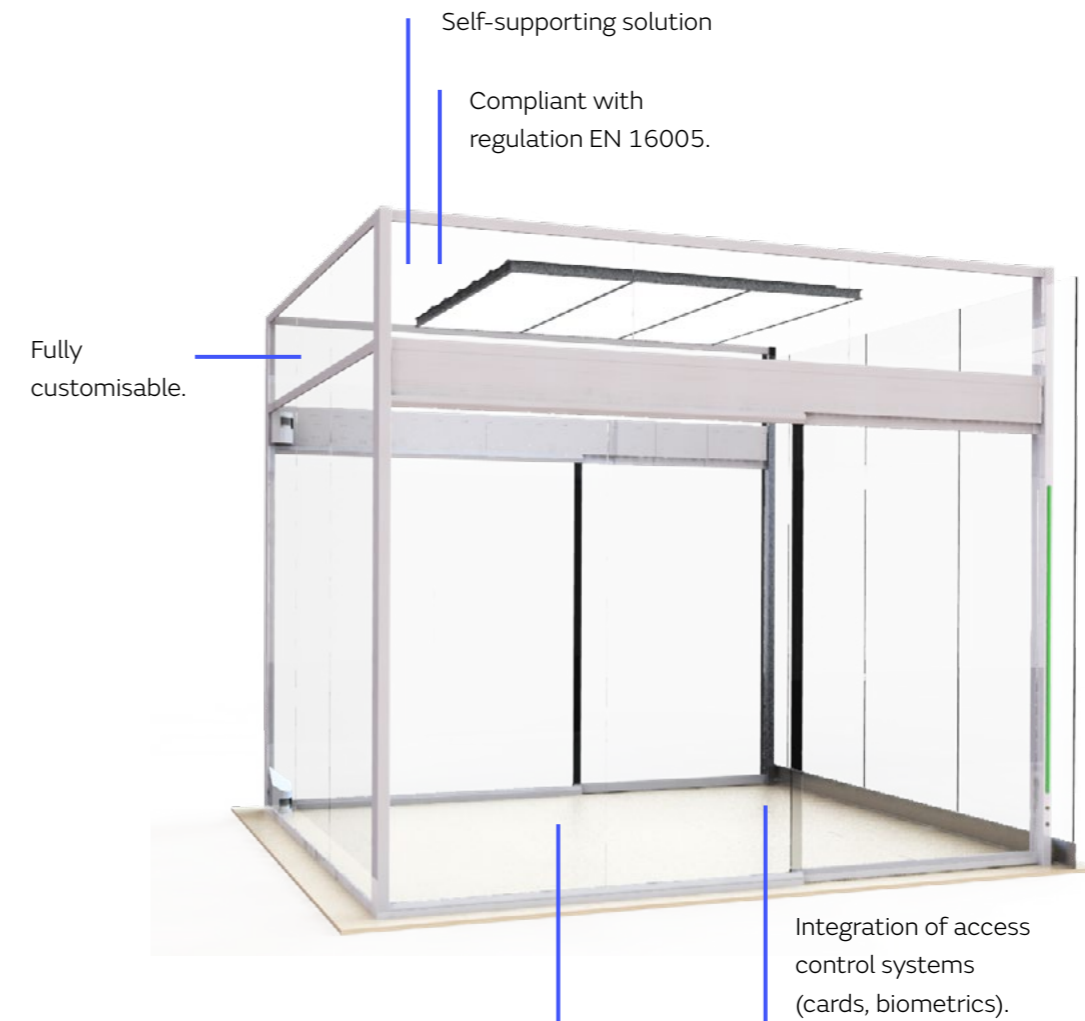

Airlock system with circular sliding door

Wide range of operating and safety accessories:
 Movement switches, pressure switches, thermal switches, vision camera systems, card readers, biometric readers, facial recognition systems, RFID readers, volumetric systems.

FAQs on hermetic doors

What distinguishes hermetic sliding doors from non-hermetic doors?

Manusa's hermetic sliding doors help to keep the room free from any external contamination, sealing the entrance to maintain a pressure differential between two adjoining rooms. They also optimise the use of treated air within a surgical area, and reduce the operating costs of an operating theatre or clean room.

In the case of clean rooms or operating theatres, clean air is pumped from inside the room, maintaining an overpressure that prevents pathogens from entering; hermetic automatic doors minimise any air leakage so the pressurisation system operates more efficiently.

Morgues, by contrast, work at a negative pressure to ensure pathogens do not leave the room. In this case the air leaving the room is filtered to remove the pathogens and clean air is pumped in.

Where can glazed hermetic doors be installed?

A common application for this type of door leaf is in ICU and CCU rooms, so that patients can be monitored and supervised from outside the room. The airtightness is guaranteed between the leaf and the frame and the floor, providing a perfectly hermetic seal around the perimeter of the door opening and therefore maintaining the positive or negative pressure (depending on the environment's specifications) in the clean room; with the added benefit of fully glazed leaves.

What materials are used to manufacture the leaves of lead-lined doors in radiology departments?

Lead-lined hermetic doors are manufactured with the same structure as standard hermetic doors, in other words, aluminium frame with a high-density polyisocyanurate (PIR) core, lead layers with the requested thickness and the final visible coatings of high-pressure laminate (HPL) or stainless steel.

What does Manusa offer in terms of maintenance and repairs?

Manusa has a professional team that will help guarantee the proper operation of your doors and protect the people that pass through them each day. Keeping your equipment up to date in accordance with current legislation is key to preventing accidents, since user safety is paramount.



HEAD OFFICE

Avda. Via Augusta, 85-87, 6th floor
08174 Sant Cugat del Vallès
Barcelona · Spain

+34 93 591 57 00
manusa@manusa.com

www.manusa.com

FACTORY

Ctra. El Pla de Sta Maria, 235-239
Pol. Ind. de Valls
43800 Valls (Tarragona) · Spain

+34 93 591 57 00
fabrica@manusa.com

www.manusa.com

D90014-EN 